

Crosby

ORW-115-P90-MZ4.1K

O|R

PRESSURE BALANCE SHOWER TRIM
FOR USE WITH SS-PB85 PRESSURE BALANCE VALVE

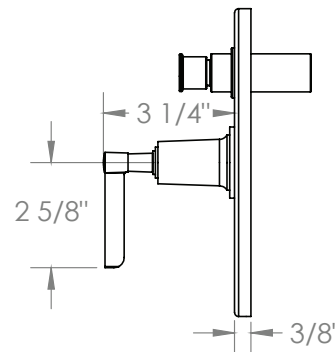
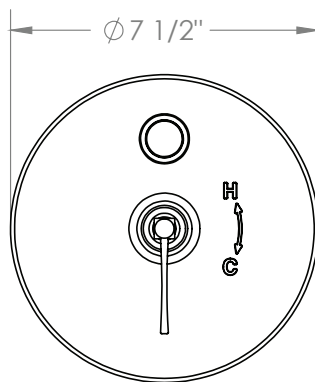

Meets the applicable requirements of ASME A112.18.1-2005/CSA B125.1-05, entitled "Plumbing Supply Fittings"