

Crosby

ORW-115-WTR-MZ4.1K

O|R

WALL MOUNTED TRIM
 INCLUDES ALIGNMENT KIT
 FOR USE WITH SS-TS200-C, SS-TS200-H, SS-TS150C, SS-TS150-H,
 SS-WD2, SS-WD3, SS-VCWD2 OR SS-VCWD3 CONCEALED ROUGH

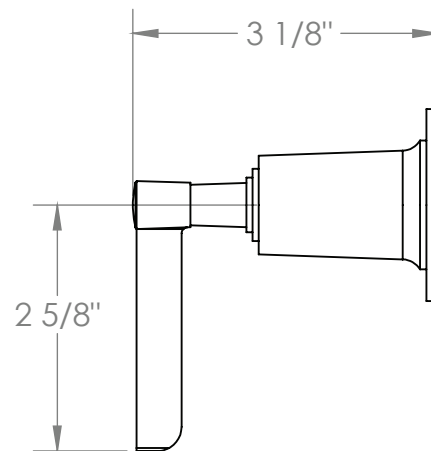
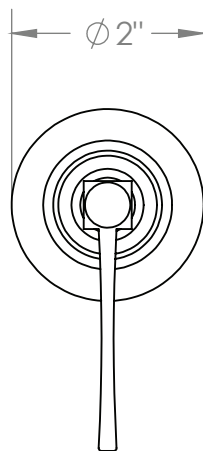

Meets the applicable requirements of ASME A112.18.1-2005/CSA B125.1-05, entitled "Plumbing Supply Fittings"