

Crosby

ORW-115-0.11-MZ4.1K

O|R

TANK LEVER

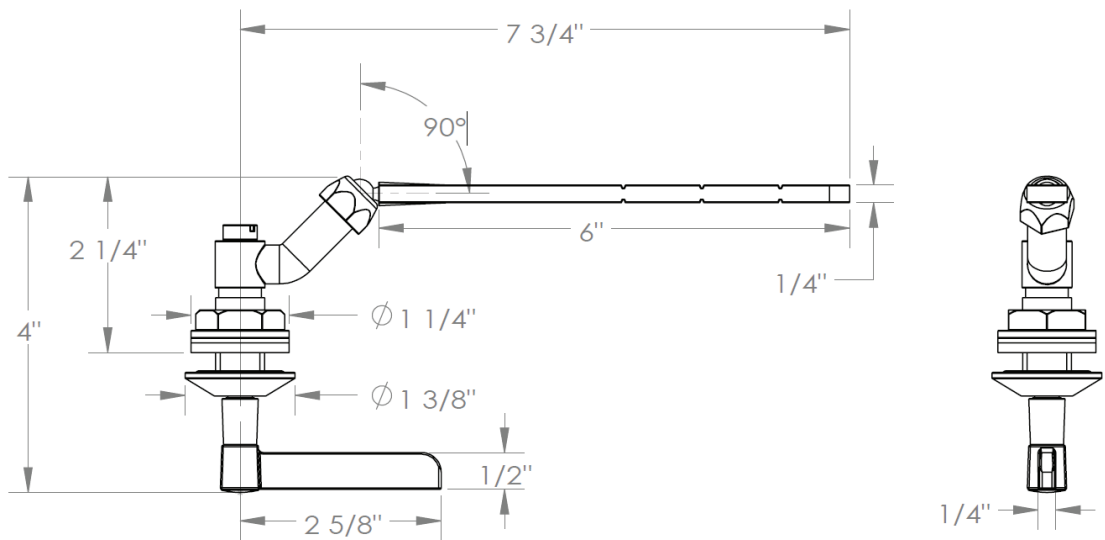
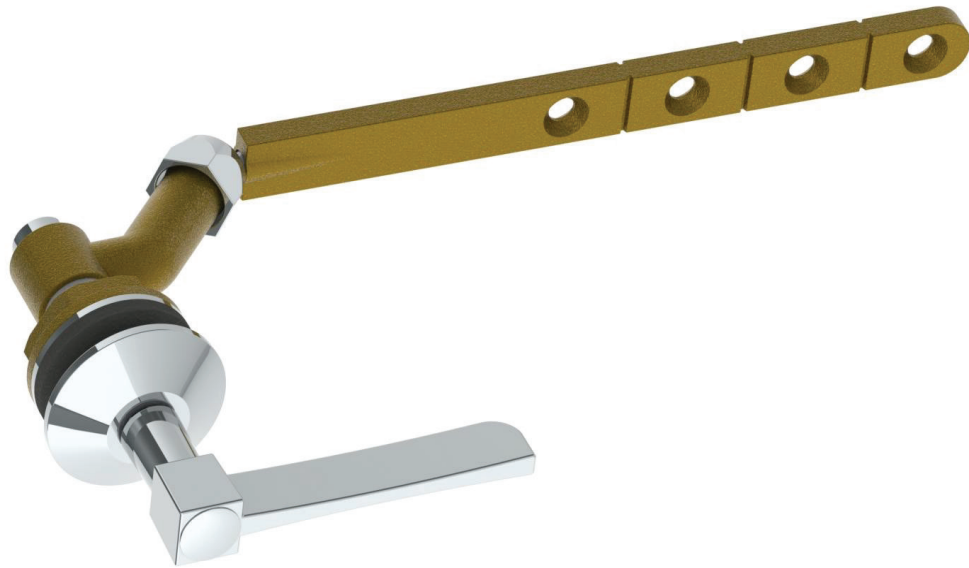

Meets the applicable requirements of ASME A112.18.1-2005/CSA B125.1-05, entitled "Plumbing Supply Fittings"