

Morgan

ORW-MG-2-MR4

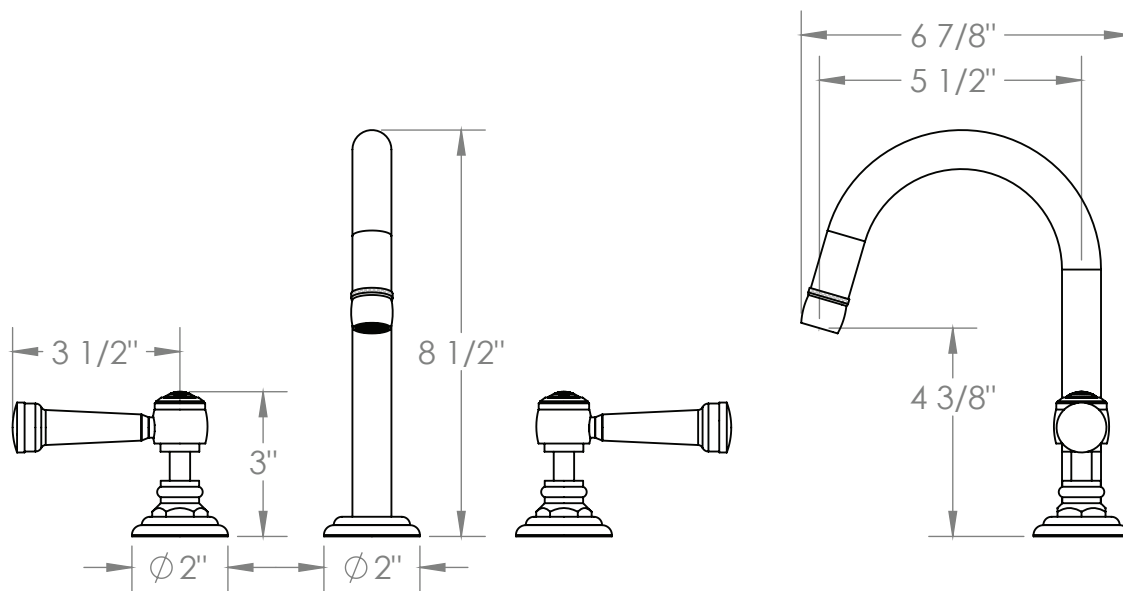

LAVATORY WIDESPREAD
 INCLUDE ORW-MPU5 POP UP DRAIN
 FLOW RATE: 1.2 GPM



Meets the applicable requirements of ASME A112.18.1-2005/CSA B125.1-05, entitled "Plumbing Supply Fittings"