

Addison

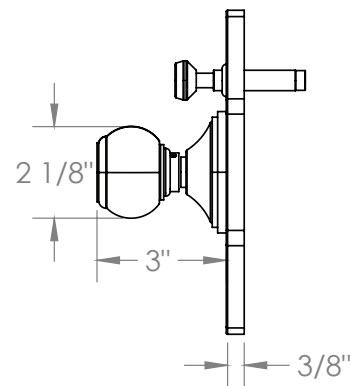

ORW-314-P90-ADT6

PRESSURE BALANCE SHOWER TRIM
FOR USE WITH ORW-SS-PB85 PRESSURE
BALANCE VALVE

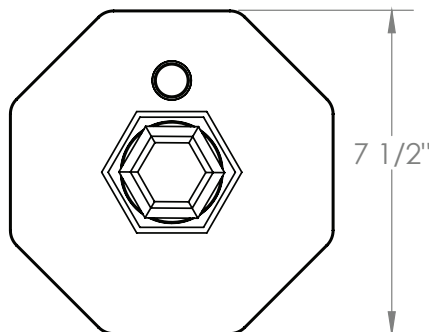

Meets the applicable requirements of ASME A112.18.1-2005/CSA B125.1-05, entitled "Plumbing Supply Fittings"