

Jonathan

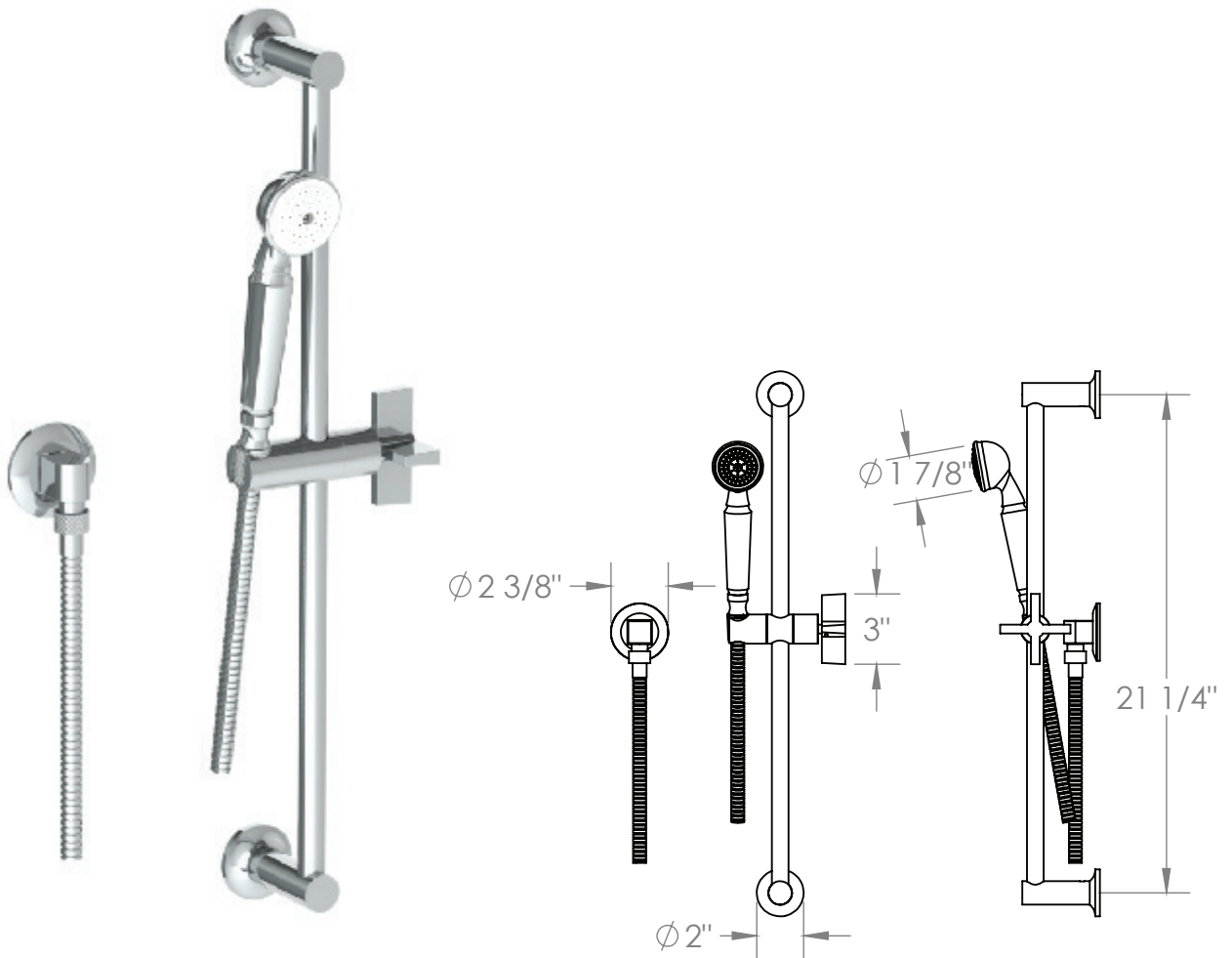

ORW-JN-HSPB1-DD5

POSITIONING BAR SHOWER KIT WITH
HAND SHOWER AND 69" HOSE
FLOW RATE: 1.75 GPM



Meets the applicable requirements of ASME A112.18.1-2005/CSA B125.1-05, entitled "Plumbing Supply Fittings"