

Jonathan

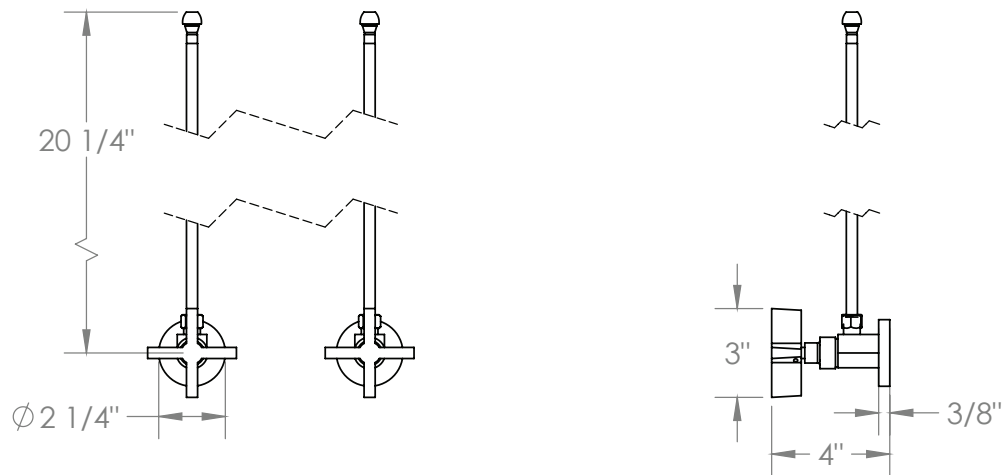

ORW-JN-MAS2-DD5

LAVATORY ANGLE STOP KIT
1/2" IPS X 3/8" OD COMPRESSION



Meets the applicable requirements of ASME A112.18.1-2005/CSA B125.1-05, entitled "Plumbing Supply Fittings"