

Claire

ORW-CL-P80-CLR6

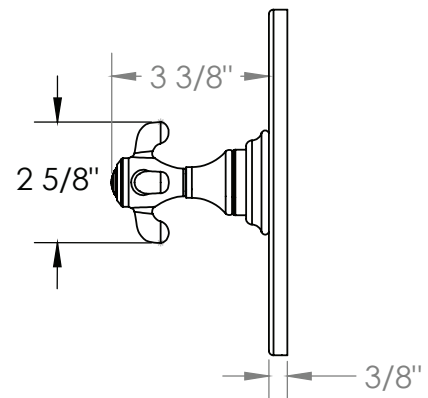

PRESSURE BALANCE SHOWER TRIM
FOR USE WITH ORW-SS-PB75 PRESSURE BALANCE VALVE

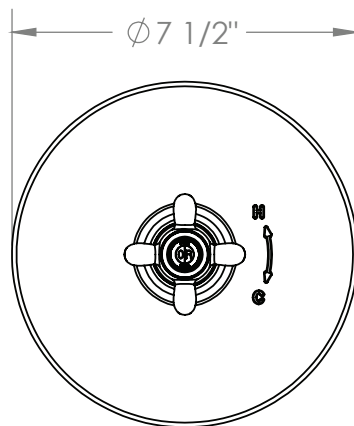

Meets the applicable requirements of ASME A112.18.1-2005/CSA B125.1-05, entitled "Plumbing Supply Fittings"