

Claire

ORW-CL-T10-CLR6

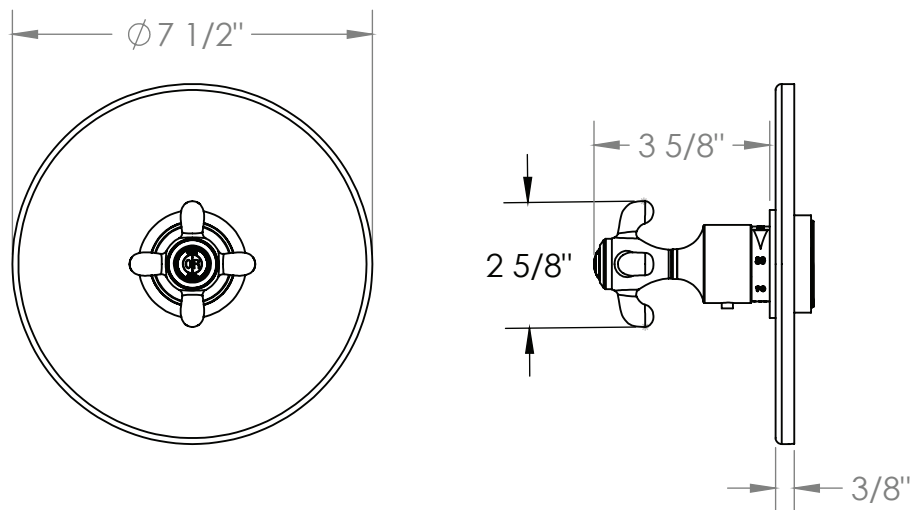

WALL MOUNTED THERMOSTATIC SHOWER TRIM
FOR USE WITH ORW-SS-TH1000 OR ORW-SS-TH3000 ROUGH



Meets the applicable requirements of ASME A112.18.1-2005/CSA B125.1-05, entitled "Plumbing Supply Fittings"