

# Claire

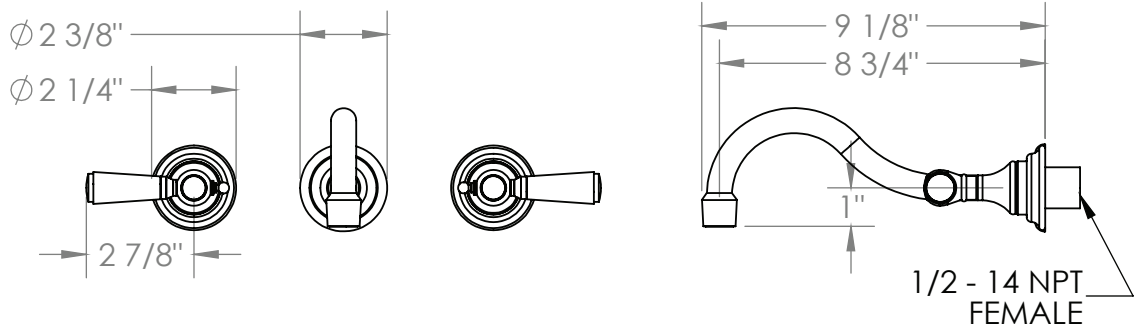

ORW-CL-2.2-CLR4

WALL MOUNTED 3 HOLE LAVATORY SET  
FLOW RATE: 1.2 GPM



Meets the applicable requirements of ASME A112.18.1-2005/CSA B125.1-05, entitled "Plumbing Supply Fittings"