

Claire

ORW-CL-2-CLR4

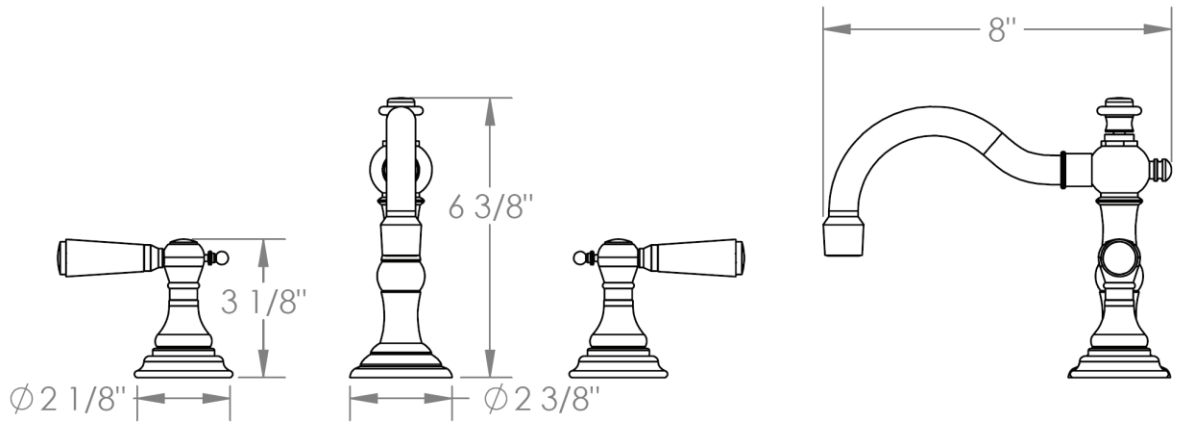

DECK MOUNTED 3 HOLE LAVATORY SET
 INCLUDES ORW-MPU7 POP-UP DRAIN
 FLOW RATE: 1.2 GPM



Meets the applicable requirements of ASME A112.18.1-2005/CSA B125.1-05, entitled "Plumbing Supply Fittings"