

Claire

ORW-CL-8.1-CLR5

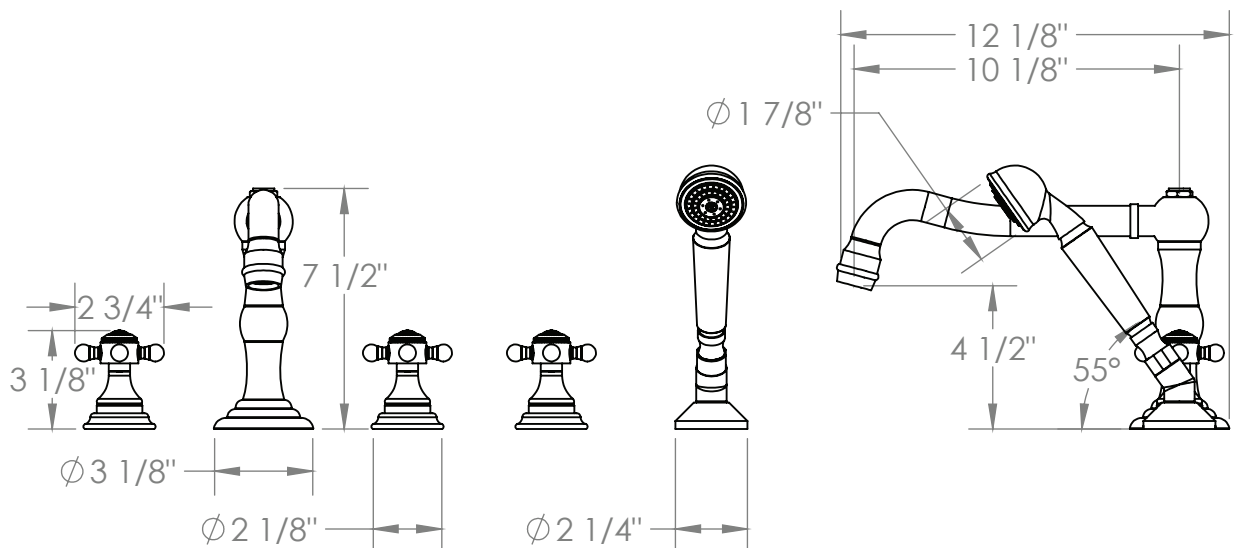

DECK MOUNTED 5 HOLE BATH SET
 HAND SHOWER FLOW RATE: 1.75 GPM
 NOTE: SOME BUILDING CODES REQUIRE REMOTE
 PRESSURE BALANCE VALVES FOR ANTI-SCALD



Meets the applicable requirements of ASME A112.18.1-2005/CSA B125.1-05, entitled "Plumbing Supply Fittings"