

Claire

ORW-CL-8.3-CLR5

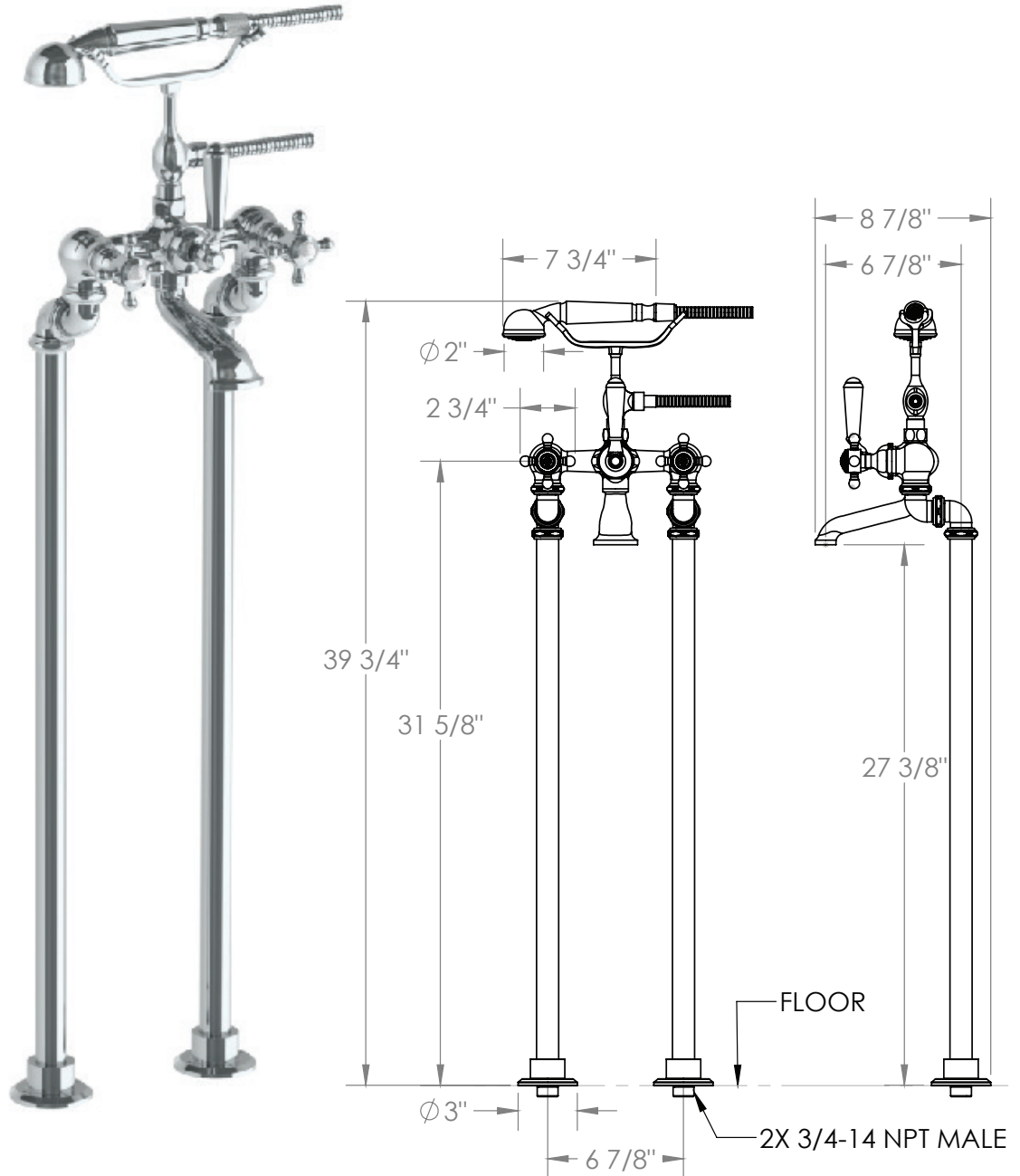

FLOOR STANDING BATH SET WITH HAND SHOWER
 HAND SHOWER FLOW RATE: 1.75 GPM
 NOTE: SOME BUILDING CODES MAY REQUIRE REMOTE
 PRESSURE BALANCE VALVES FOR ANTI-SCALD



Meets the applicable requirements of ASME A112.18.1-2005/CSA B125.1-05, entitled "Plumbing Supply Fittings"