

# Claire

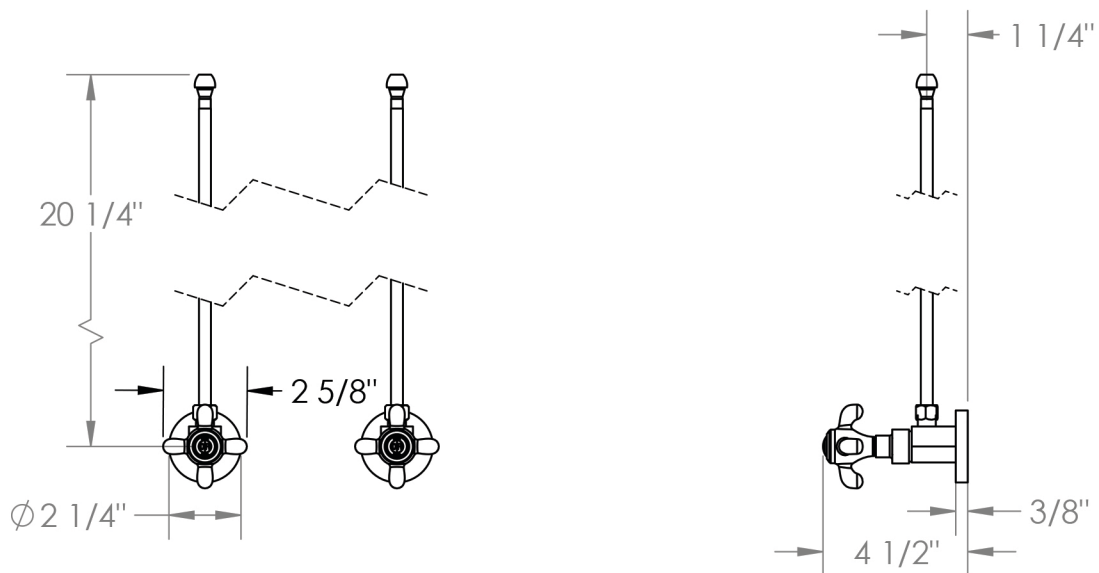

ORW-CL-MAS2-CLR6

Lavatory Angle Stop Kit  
1/2" IPS x 3/8" OD Compression



Meets the applicable requirements of ASME A112.18.1-2005/CSA B125.1-05, entitled "Plumbing Supply Fittings"